

N395 AC

**N**

YACHTS *of* SWEDEN





## We always design the yacht around you

When you choose Najad, you have the opportunity to put your mark on one of the most enjoyable investments of your life. Together with our team of top competence in all areas of boatbuilding, you can personalize your yacht to become a personal statement. An expression of individuality and style linked to your needs on board. This interaction is a vital dynamic in our being. It constantly challenges and develops us. It keeps us at the forefront of boatbuilding, and allows us to put our mark on those magical moments.

### A history of shipbuilders

Our heritage dates back to the first boatmen on the island of Orust, Sweden. They were followed by generations of skilled boatbuilders, sailors and fishermen, who lived and sailed under harsh conditions. The sea dictated the conditions and was a constant reminder of the vital necessity of quality in all things. Coming from this tradition, the first Najad was introduced in the early 1970s. The stability and sailing dynamics were a revelation. Ever since, Najad has been a leader in developing the boatbuilding tradition.



*The Najad brand stands for quality, robust design, craftsmanship and comfort. The yachts are true blue water cruisers with an unprecedented attention to details, safety, and user friendliness. Everything from the design process to the naval architect work of the yachts are carefully thought thru. The yachts are easy to keep in the best condition due to the very high build standard. If you are looking for the best overall yacht in the 40 to 60 feet range then Najad is the obvious choice for you. Many thanks for your attention and please enjoy the Najad experience.*

*Yours Sincerely  
Jörgen Ottosson, CEO Najad*



## Say Hello to a true Mini Superyacht

Najad 395 AC is part of the all new Najad 395 range, designed in a joint venture between Najad, Farr Yacht Design – The top racing-yacht design team in the world and Ken Freivokh Design – Superyacht stylist, architect, and interior designer with the world's most impressive reference list. There has never been a better sailing yacht under 40 feet than the Najad 395 range. Focus when developing the yacht has been on safety, sailing performance, comfort, long distance cruising and luxury.

Najad 395 aft cockpit (AC) is characterized by a large Caribbean style cockpit with twin helm stations. It has a well-designed interior, and a very comprehensive option list that includes all equipment necessary to tailor the yacht to any individual needs.

This boat is truly a Mini Superyacht in all aspects from build standards and technical installations to design features, premium materials, and top of the line equipment. The yacht is simply built to last a lifetime of hard sailing in difficult conditions and still have its value left.



## Designer's comments



*Our goal at Farr Yacht Design with the new Najad395 was to look back at Najad's history, as well as forward to their future, and to create two new 12m models that would help take important steps forward while remaining true Najads. The brand Najad has so much great heritage, that our steps as thoughtful designers had to be very carefully considered. The 395 that we have created together is an artful blend of performance improvements and industrialization, with traditional values, sea worthiness, and good solid engineering. Both versions of the boat, center cockpit and aft cockpit, have been developed with the attention deserving of single focus models, and yet have achieved a level of industrialized integration which is a real testament to the team. We are confident that we have created new Najad395's that can stand the test of time, and be rewarding, and confidence inspiring yachts for her owners well into the future.*

Patrick Shaughnessy  
President, Farr Yacht Design



*The team at Ken Freivokh Design were delighted to tackle the challenge of creating unique interiors for both aft-cockpit and centre-cockpit version of the Najad 395, conceived from day one to offer maximum flexibility and choice. Such customer choice is almost unheard of on production sailing yachts, and showcases Najad's intention to offer their customers a solution which most closely match their needs and preferences. The very fact that such options have been carefully considered from inception of the project ensures that they have been properly allowed for and implemented. Such options range from full three cabin, two shower room layouts to comfortable two cabins with ample room for storage, utility and toys, so all permutations to ensure that the owner's intended use is fully catered for. The broad range of choices extends to the offered materials and colour choices, including a variety of woods, upholstery materials and colours and a range of finishes which should ensure that prospective owners end up with exactly the boat of their choice.*

Ken Freivokh  
Chief exec., Ken Freivokh Design





Spring loaded washboard made of hardened laminated dark glass.

Solid teak on deck, coachroof, bathing platform and in cockpit area.

Main sheet tacking in the optional arch or in a rail or pad eye mounted aft of cockpit.

Steering pedestal head with grab handle and all functions for single handed sailing.

Hydraulic back stay tensioner.

Stainless steel pushpit with integrated teak seats.

High safety with ISAF life raft mounted on pushpit.

Generously equipped with two winches on each side as standard. Giving the flexibility of always having a free winch for quick maneuvers.

Large foldable bathing platform with integrated ladder and optional electric maneuvering controlled from cockpit.

Elegant and safe with flush mounted deck hatches.

Pulpit in stainless steel with integrated teak step. Especially designed for easy boarding.

Easy removable stainless steel bow sprit for tacking of sails, anchor support and fitting a bow ladder.

Keel stepped mast for maximum stability, strength and safety.

Six ventilators and the four opening skylights provide a good climate and ventilation on board.

Clean and safe with halyard lead through coachroof.

Premium quality stainless steel self-tailing winches.

Lots of natural light through the many openable skylights and portlights.

## Beautiful and practical exterior design

The impressive engineering and design work on the Najad 395 range performed by the top racing-yacht design team in the world Farr Yacht Design will not pass anyone unnoticed. The all new Najad 395-range has excellent seagoing capabilities. The bow and hull is designed for smooth wave piercing in heavy seas. It is very dry on deck even in rough weather, due to ocean going design. This holds true both under power and sails.

The deck layout on N395 AC is clean and uncluttered with under deck mounted electric windlass and flush mounted deck hatches and skylights. The large lockers, one drained in bow, one in the cockpit floor and two on aft deck provides generous storage for sails and deck equipment.

The generous wide and lengthy Caribbean style cockpit with twin helm stations provides plenty of space for winching, tacking, and trimming. The cockpit is also well protected and safe which makes it a very sociable place to entertain family and friends when either under way or when mooring in a nice and quiet bay. The broad stern with the large foldable bathing platform, easily maneuvered from the cockpit, is perfect for water sport activities.



White hull with red stripes  
(standard)



White hull with silver grey stripes  
(optional)

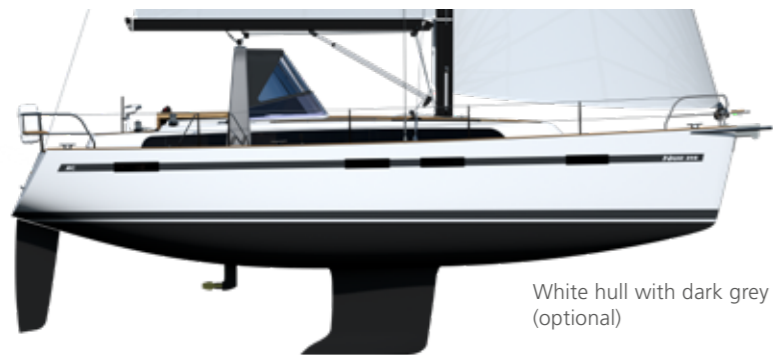

White hull with dark grey stripes  
(optional)



## Exterior styling

The customization of a Najad is not limited to technical equipment and layout selection. When choosing Najad you can also put a mark on the exterior look of your yacht.

N395 AC comes as standard with a white hull with hall-mark Najad red stripes and a pearl white canvas on sprayhood. Optional colors include silver or dark grey color on trim and water line and/or sprayhood. Mix and match as you like according to your preferences.

Additional colors and hull and deck coloring is available on request.

### HULL TRIM

Trim and water line.



Red stripes  
(standard)



Silver grey stripes  
(optional)



Dark grey stripes  
(optional)

### FABRICS

Sprayhood, sprayhood extension, bimini and table cover.

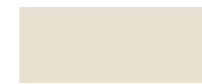

Pearl white  
(standard)



Silver grey  
(optional)



Dark grey  
(optional)

## Arch over cockpit

The optional arch increases the safety and protection of the cockpit. The tacking of the mainsheet on top of the arch reduces the risk of injuries from an unexpected jibe. The arch constitutes a good handle when moving in and out of the cockpit, enables lighting underneath, conveniently attaches the sprayhood and is a natural stow away place for the sprayhood extension.

## Sails

The sails for N395 AC are made of high quality, laminated cloth from UK Sailmakers – one of the world's most established groups of sail makers with over 50 lofts and service centers.



Crosscut Flex  
(standard)



X-drive S-glas  
(optional)



X-drive Carbon  
(optional)

## Rigging

N395 AC is equipped with rigging from Seldén – the worlds leading manufacturers of spar and rigging systems. An aluminium mast with two spreaders and furlex are standard. In-mast furling with or without an electric motor is available as an option. There is also the option of carbon fiber or white or black laquerering of mast, boom and rod kick.



Electric Furlex  
(optional)



In-mast Furling  
(optional)



## Saloon and galley

The impressive interior design work on the N395 AC performed by top-ranking superyacht stylist Ken Freivokh will not pass anyone unnoticed. Every little detail inside this yacht is carefully selected and well thought out. The material selections and design details with luxurious superyacht influences creates a home away from home feeling.

The truly breathtaking saloon and galley offers a great living area with lots of natural light coming from the many skylights and portlights. The headroom is an impressive 2,00 meters.

The Najad signum of a large seagoing galley is of course retained in the Najad 395 range. The galley offers all possible kitchen equipment such as double sinks, large separated fridge and freezer, microwave, stove, and oven. The dining area with its body adopting comfortable sofa and the large foldable table, seats at least six comfortably enjoying a fabulous well-cooked meal.

Depending on layout selection and demands for navigation area options includes a proper large forward-facing navigation station on starboard side, conveniently beside the companionway offering a good contact to the cockpit and saloon.

*Please note pictures are showing optional oak interior.*





## Cabins and suites

The total number of layouts and combinations on Najad 395 are unprecedented in the class of 40-foot yachts. N395 AC is available in two or three cabin layouts with one or two large heads.

The forward super cabin with its comfortable full queen size double berth, lavish design details, natural light from large skylight and glass panels creates a roomy and bright atmosphere. The super cabin also have its own walk-in closet. Selectable layouts in front of the mast includes an additional head or a separate shower room with just a shower to port and a seating option to starboard. It's all up to you to decide and customize according to your needs.

The standard layout has two aft suites with lengthy and wide beds and large wardrobes for excellent stowage for long-stay clothing and personal effects. For those wanting more space instead of sleeping places there are two options to change the starboard aft suite into an optional storage area with shelves and compartments. One of the options also includes a proper forward-facing navigation station with a seat.

The heads and shower rooms on N395 AC holds the hallmark Najad standard with good ventilation, large Corian worktops, lots of storage in lockers and cabinets and roomy showers – all made of top of the line materials.

*Please note pictures are showing optional oak interior.*



# Interior styling and customization

The interior of N395 AC is characterized by top quality craftsmanship and woodwork, executed with extreme attention to detail. Joinery of interior and cabinets are screwed and glued for optimal strength and to avoid unwanted sounds.

The yacht comes as standard with a classically Najad hallmark mahogany furnishing with options for both white oak and teak. Throughout the interior you'll find contrasting finish/color on selected details such as inlays and skirtings in doors, companionway, and saloon table.

When it comes to personalizing the interior, N395 AC is a dream come true for those who value customizing. Colors, fabrics, worktops and more can be matched in many different styles and colors to build a unique yacht.

How would you like it?

## WOODS



Mahogany (standard)

White oak (optional)

Teak (optional)

## FLOORING

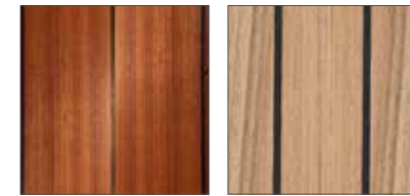

Jatoba with dark stripes (standard)

Teak with dark stripes (optional)

## BULKHEADS



Mahogany (standard)

Platinum white (optional)

## WORKTOPS IN GALLEY AND HEADS

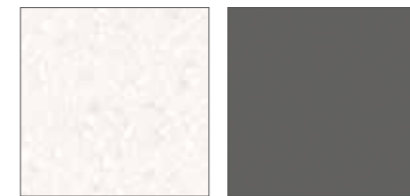

Corian® - Antarctica (standard)

Corian® - Deep cloud (optional)

## SOFA UPHOLSTERY CHENILLE



Cream white (standard)

Navy blue (optional)

## SOFA UPHOLSTERY MARINE LEATHER



Bianco (optional)

Ischia navy (optional)

## SOFA UPHOLSTERY ALCANTARA

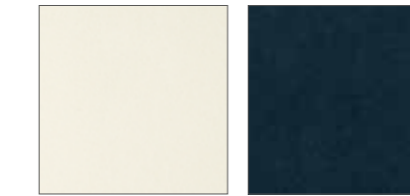

Eggshell (optional)

Navy (optional)

## BED COVER



Red arrow (standard)

Blue arrow (optional)

Red stripes (optional)

Blue-white stripes (optional)

## CURTAINS



Ultramarine (standard)

White (optional)

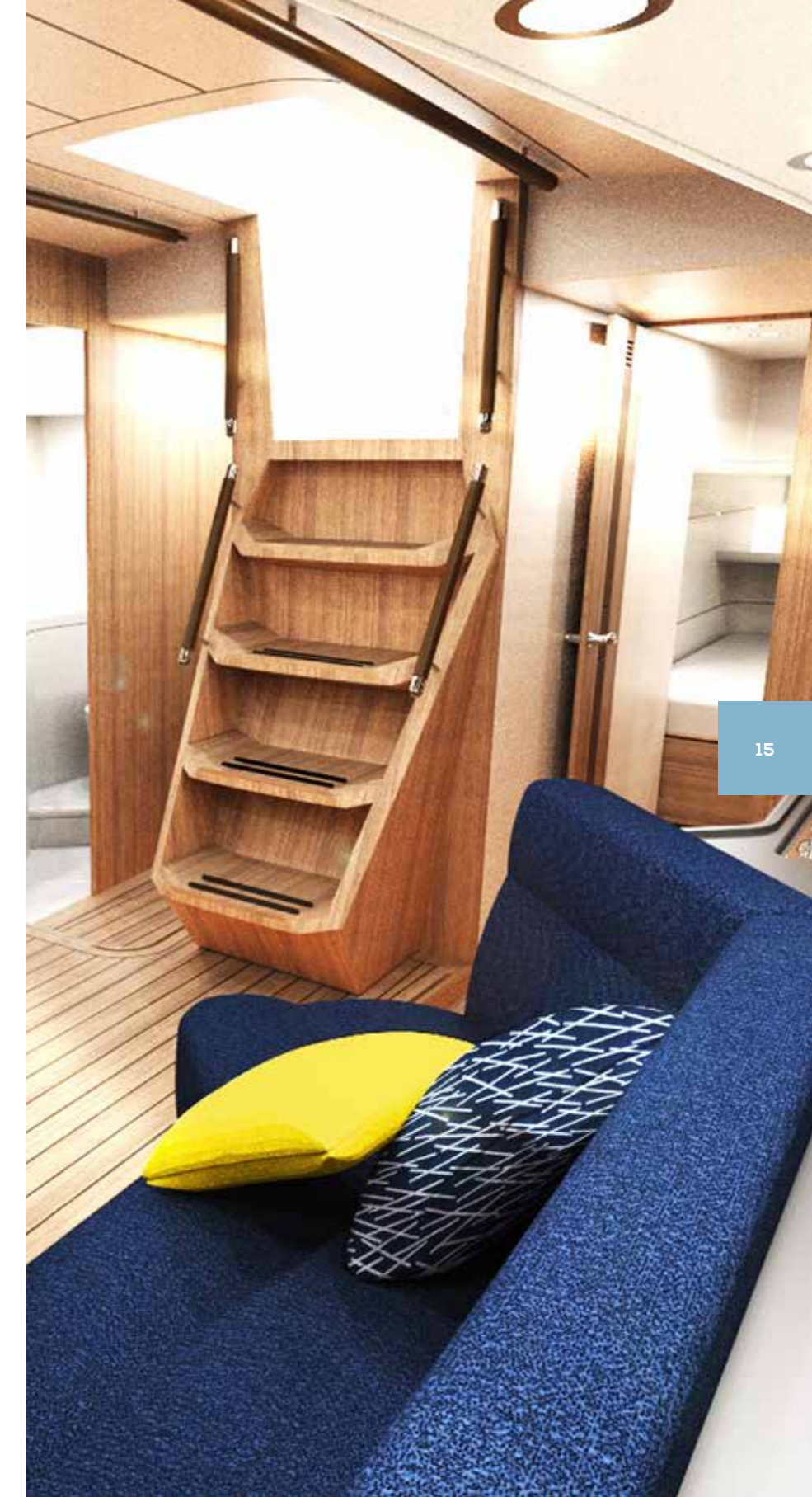



# Unprecedented build standard

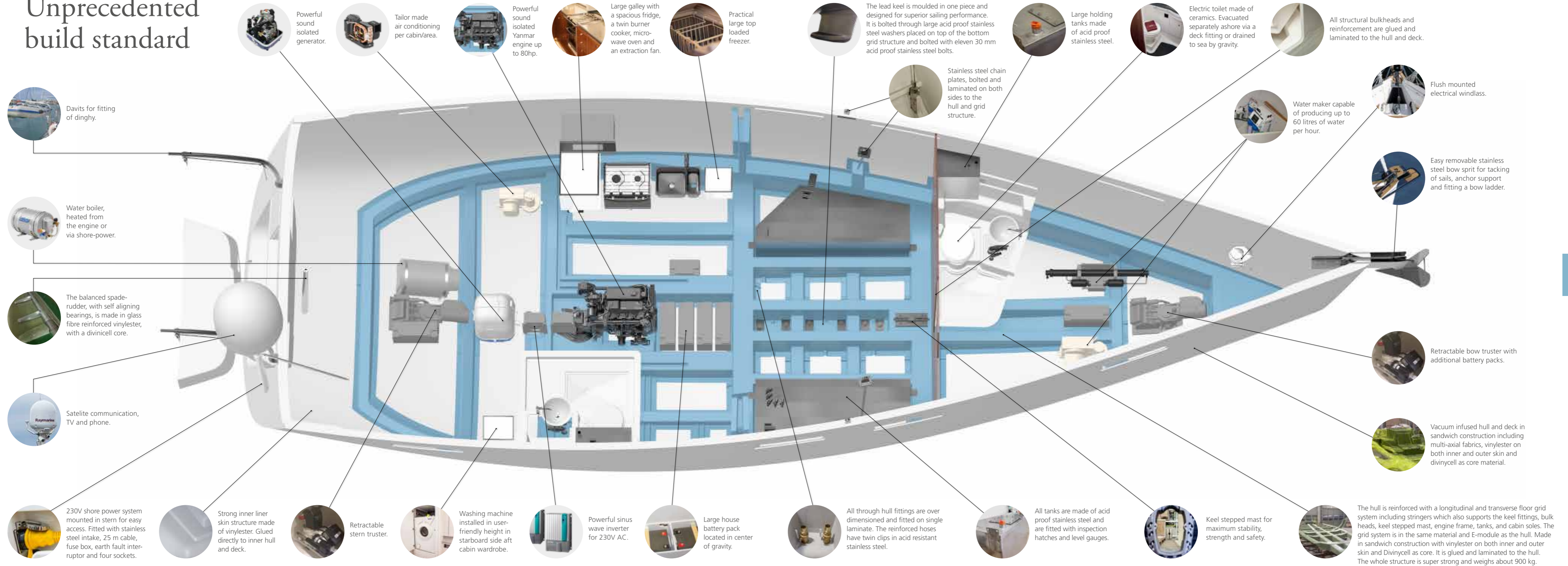

Davits for fitting of dinghy.

Water boiler, heated from the engine or via shore-power.

The balanced spade-rudder, with self aligning bearings, is made in glass fibre reinforced vinylester, with a divinycell core.

Satellite communication, TV and phone.

230V shore power system mounted in stern for easy access. Fitted with stainless steel intake, 25 m cable, fuse box, earth fault interruptor and four sockets.

Strong inner liner skin structure made of vinylester. Glued directly to inner hull and deck.

Retractable stern truster.

Washing machine installed in user-friendly height in starboard side aft cabin wardrobe.

Powerful sinus wave inverter for 230V AC.

Large house battery pack located in center of gravity.

All through hull fittings are over dimensioned and fitted on single laminate. The reinforced hoses have twin clips in acid resistant stainless steel.

All tanks are made of acid proof stainless steel and are fitted with inspection hatches and level gauges.

Keel stepped mast for maximum stability, strength and safety.

The hull is reinforced with a longitudinal and transverse floor grid system including stringers which also supports the keel fittings, bulk heads, keel stepped mast, engine frame, tanks, and cabin soles. The grid system is in the same material and E-module as the hull. Made in sandwich construction with vinylester on both inner and outer skin and Divinycell as core. It is glued and laminated to the hull. The whole structure is super strong and weighs about 900 kg.

Powerful sound isolated generator.

Tailor made air conditioning per cabin/area.

Powerful sound isolated Yanmar engine up to 80hp.

Large galley with a spacious fridge, a twin burner cooker, micro-wave oven and an extraction fan.

Practical large top loaded freezer.

The lead keel is moulded in one piece and designed for superior sailing performance. It is bolted through large acid proof stainless steel washers placed on top of the bottom grid structure and bolted with eleven 30 mm acid proof stainless steel bolts.

Stainless steel chain plates, bolted and laminated on both sides to the hull and grid structure.

Large holding tanks made of acid proof stainless steel.

Electric toilet made of ceramics. Evacuated separately ashore via a deck fitting or drained to sea by gravity.

Water maker capable of producing up to 60 litres of water per hour.

All structural bulkheads and reinforcement are glued and laminated to the hull and deck.

Flush mounted electrical windlass.

Easy removable stainless steel bow sprit for tacking of sails, anchor support and fitting a bow ladder.

Retractable bow truster with additional battery packs.

Vacuum infused hull and deck in sandwich construction including multi-axial fabrics, vinylester on both inner and outer skin and divinycell as core material.

# Specifications and layout

## TECHNICAL SPECIFICATION

Length overall	11,99 m
Length waterline	10,98 m
Beam	4,00 m
Draught	2,10 m
* Alternative shallow draught	1,80 m
Displacement	12 400 kg
Ballast	4 400 kg
Mast height above water line	20,15 m
Engine	Yanmar 4JH57 (41,9 kW) 57 hp
Fuel capacity (optional)	370 litres (165 litres)
Water capacity (optional)	370 litres (165 litres)
Holding tank	75 litres

## HULL, DECK AND KEEL MATERIALS

Vacuum infused sandwich construction	
Hull & deck material	E-Glass Vinylester/Polyester
Core material	Divinycell
Keel type	Lead bulb

## SAIL AREAS

Cruising	89 m <sup>2</sup>
Full batten main	48 m <sup>2</sup>
Furling jib	41 m <sup>2</sup>
Code 0	76 m <sup>2</sup>
Spinnaker	123 m <sup>2</sup>
Gennaker	125 m <sup>2</sup>
Heavy staysail, main	14 m <sup>2</sup>
Heavy staysail, JIB	12 m <sup>2</sup>

## DESIGN AND CONSTRUCTION

**NAJAD**  
YACHTS of SWEDEN

**FARR**  
YACHT DESIGN

**KEN FREIVOKH**  
DESIGN

### Reservations

Najad believes the specifications in this brochure to be correct at the time of printing, however, there is always the possibility of details being changed. This can be due to model year changes, printing errors, price adjustments or other reasons. In respect of the legal purchase terms, this is only a guideline to describe the product. Najad especially reserves the right to change the design and reduce or change the standard equipment, the choice of products, materials and the technical solution of the product without notice. The yachts in this brochure may show optional equipment.

Valid from 2017-12-01. Replaces all previous brochures.



## DECK LAYOUT



## INTERIOR LAYOUT

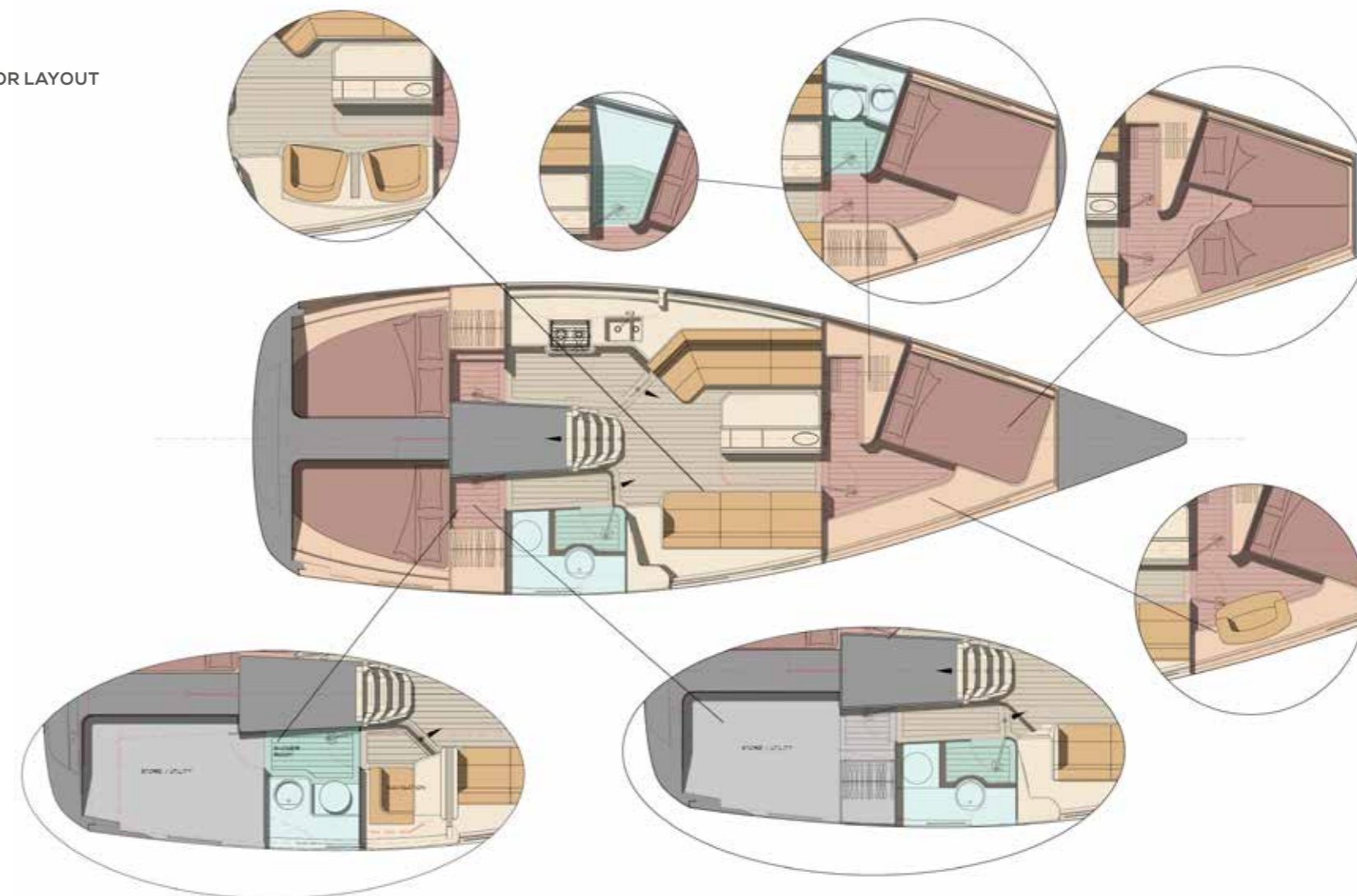



N395 AC



N395 CC



N450 CC



N505 CC  
NEXT GENERATION



N570 CC

THE  
N395  
LEGACY  
CONTINUES...

